

# Data Sheet



Article number: 03445025

Description: Fluro Heavy Duty Spherical Plain Bearing GE 25 EW-2RS  
Hole Ø25

Note: 25

## Measures

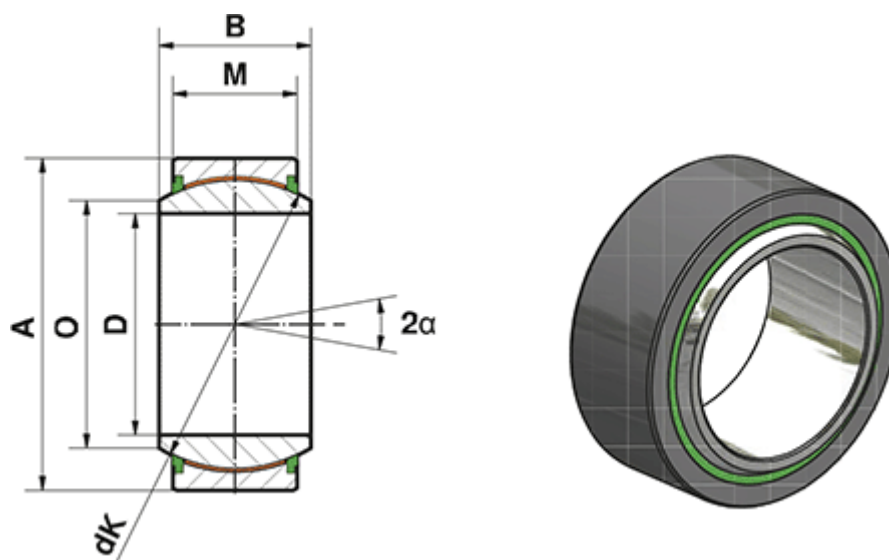

A	= 42	Static load C0 (kN) = 212
a (degrees)	= 7	Weight (g) = 110
B	= 20	
D	= 25	
dk	= 35.5	
Dynamic load C (kN)	= 127	
M	= 16	
O	= 29.3	